

# 高清网络摄像机

HD IP Camera

**KEDACOM**

快速安装指南

Quick Start Guide



## 一、前言

感谢您购买我司产品，如对本公司产品有疑问或需要，请随时和我们联系。

此内容（手册）的目的是确保用户正确使用本产品，以避免危险或财产损失。在使用产品之前，请认真阅读此手册并妥善保存以备日后参考。如果用户因没有按照以下安全说明，致使设备不能正常使用或损坏等情况，我司恕不负责，感谢您的配合。

## 二、安全使用注意事项

### 1. 电源要求

- 请在安装使用设备过程中，严格遵守当地各项电气安全规定。
- 请使用满足安全电压要求的电源，在设备运行之前检查供电电源是否正确。
- 请在安装配线时装入易于使用的断电设备，以便必要时进行紧急断电。
- 请保护电源软线免受踩踏或紧压，特别是在插头、电源插座和从装置引出的接点处。
- 请在断电状态下连接电源、告警、音频、RS485等线缆，严禁在设备上电的情况下连线。

### 2. 使用环境要求

- 请勿将摄像机对准强光（如灯光照明、太阳光等处）聚焦，否则容易引起过亮或漏光现象（这并非摄像机故障）也将影响摄像机寿命。
- 请在允许的湿度和温度范围内运输、使用和存储设备。
- 请勿将设备置于潮湿、多尘、极热、极冷、强电磁辐射或照明条件不稳定等场所。
- 请勿让任何液体流入设备，以免内部元件受损。
- 请勿阻挡设备附近的通风口，以免热量积蓄。
- 请在运送设备时，重新以出厂时的包装进行包装，或用同等品质的材质包装。
- 请勿在运输、存储及安装过程中重压、剧烈震动、浸泡设备。
- 本产品非密封防水设备，不能单独工作于室外露天环境。

工作环境	
工作电源	DC12V±10%/POE，功耗：11W Max
温度	-40°C ~ +70 °C
湿度	10%~95%（无凝结）
海拔高度	-60m~3000m
大气压	86kPa~106kPa

### 3.日常维护与保养

- 请勿直接接触设备发热部件，以免烫伤。
- 镜头沾染灰尘或油脂时，用棉布或镜头清洁布擦拭。若遇污垢难以清除，蘸上少量镜片清洁液，自镜头中心向外旋转轻轻擦拭，直到干净为止。禁止使用有机溶剂（苯、酒精等）对镜头和护罩前脸进行除尘、清洁。
- 请不要以任何方式拆卸或修改产品。（对未经认可的修改或维修导致的问题，本公司不承担任何责任）。
- 如果设备工作不正常，请联系经销商或最近的服务中心。

### 4.特别声明

- 本手册中的图示仅供参考，产品请以实物为准。
- 我们尽最大努力来保证本手册信息的正确性，如因升级等原因发生信息修改，恕不另行通知。
- 本手册能作为多个型号产品的使用指导，但并不一一列举每个产品的使用情况，请您根据实际产品自行对照。
- 本产品使用IPCSearch激活后方能使用，激活时请填写有效邮箱，方便找回密码。IPCSearch请至官网下载，下载地址：<https://www.kedacom.com/softtools/index.jhtml>
- 为了提高产品网络使用的安全性，建议您设置高强度密码：密码长度必须达到8-16个字符，且至少由数字和字母或特殊字符中的两种或两种以上类型组合而成。请您定期更改用户名的密码，建议每3个月更新一次密码。如果设备在较高安全风险的环境中使用，建议每月或每周更新一次。请妥善保管好您的用户名与密码。
- 将本产品接入互联网需自担风险，包括但不限于产品可能遭受的网络攻击、黑客攻击、病毒感染等，本公司不对因此造成的产品工作异常、信息泄露等问题承担责任，本公司将及时为您提供产品相关技术支持。
- 如需获取最新文档，请至官网下载，官网地址[www.kedacom.com](http://www.kedacom.com)。

### 三、外观及接口

外观尺寸：

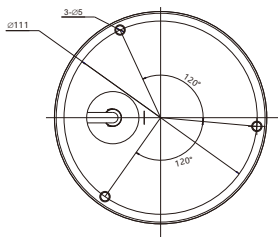
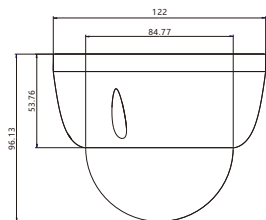

单位：mm

外观部件：

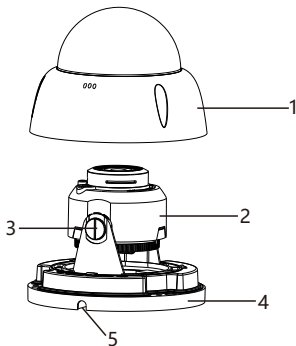

部件	部件名称
1	半球护罩
2	半球机芯模块
3	镜头角度调节螺钉
4	半球底座
5	侧出线孔

尾线：



表1 线缆接口介绍

接口	接口名称	功能描述
1	用户线缆组合	包含告警输入/输出，音频输入/输出，RS485串口等
2	视频输出接口	本地视频输出复合视频信号，BNC接口
3	电源接口	连接DC12V电源
4	网络接口	连接交换机等网络接入设备

表2 用户线缆组合接口介绍

接口名称	序号	颜色	接口名称	功能描述
用户线缆组合	1	黄	RS-485-A	RS485串口，与外界设备交互控制，如控制第三方设备
	2	绿	RS-485-B	
	3	粉红	AUDIO IN-1	音频输入接口，输入音频信号或进行语音对讲
	4	白	AUDIO IN-2	
	5	黑/白	AUDIO OUT	音频输出接口，输出音频信号
	6	浅绿	AUDIO GND	音频接地
	7	灰	ALARM IN	告警输入接口，输入告警信号
	8	红	ALARM IN GND	告警输入接地
	9	蓝	ALARM OUT-1-A	告警输出接口，输出告警信号
	10	紫	ALARM OUT-1-B	

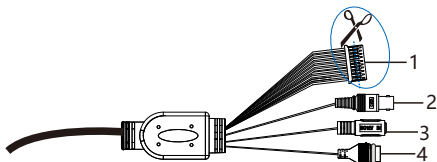
## 四、设备安装

设备支持吸顶安装、墙面安装、吊装、壁装。

吊装和壁装需配合支架进行安装，设备本身不含支架，请根据实际需求进行选配。

整机重量：0.6kg（不含包装）

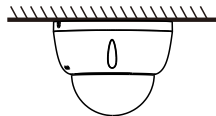

吸顶安装

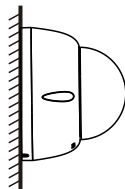

墙面安装

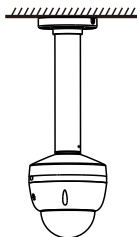

吊装

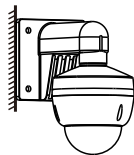

壁装

将设备安装在室外环境时，需配合防水接线盒进行安装，以达到良好的防水效果。防水接线盒属于选配件，请联系供应商或客服购买。

防水接线盒及安装效果图如下所示。防水接线盒的安装方法请参考其快速安装指南。

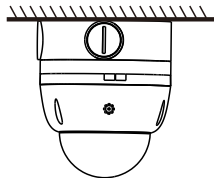
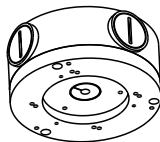
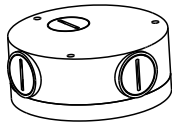

### 吸顶安装：

吸顶安装和墙面安装方式相同，本节以吸顶安装为例介绍其安装步骤。安装过程中请注意透明球罩的内外清洁。

当设备安装的墙体或天花板厚度和硬度适合固定自攻螺钉，同时其强度也能够承受设备的重量时，您可以进行吸顶安装或墙面安装。

1、取下护罩。用螺丝刀拧开半球护罩上的三颗十字盘头防拆螺钉，取下半球护罩。

操作时请注意以下几点：

- 护罩取下后放置时不要将透明罩直接放置在地面，避免刮花。
- 操作过程中，不要划伤透明罩，否则会影响图像效果。
- 不要撕下透明罩内外的保护膜，待后续安装完成后再撕。

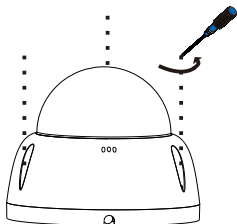

2、安装TF卡（可选）。在如下图所示TF卡槽位置插入TF卡。TF卡容量最大支持256G，插入TF卡后，不建议对其进行热插拔。

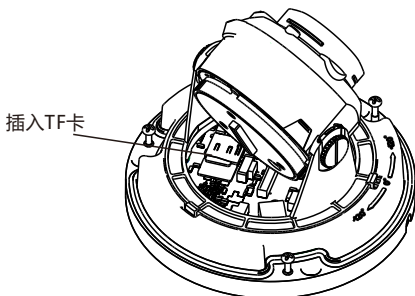

3、安装贴纸。取出设备附件中的安装贴纸，根据监控区域，将其粘贴在天花板或者墙壁等安装面上。贴纸尺寸如下图所示。



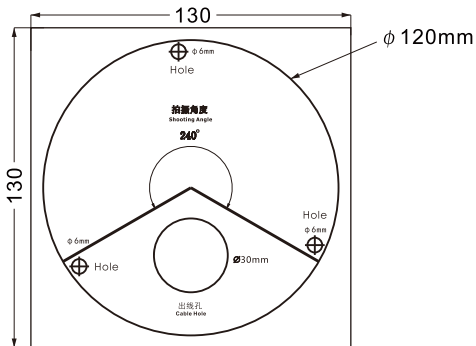

- 4、打孔。在安装定位图上带有“十字”标记的三个孔位处，打出三个塑料膨胀螺栓底孔，将三颗膨胀螺栓完全塞入到安装孔中。

**【说明】**如果在安装线缆时采用从安装面顶部出线的方式，还需要在安装贴纸标有“出线孔”的位置打一个线缆出孔开口。如果采用从设备侧面出线的方式，需要通过半球底座上的U型线缆通道侧口，将线缆引出。

- 5、将设备底座固定在墙面。调整好设备安装底座的位置，将线缆引入到安装面上的出线孔中，再将设备安装底座上的三个螺丝固定孔对准安装面上的三个塑料膨胀螺栓固定孔，然后将三颗自攻螺钉拧紧到三个塑料膨胀螺栓中，并锁紧，将半球固定在安装面上。

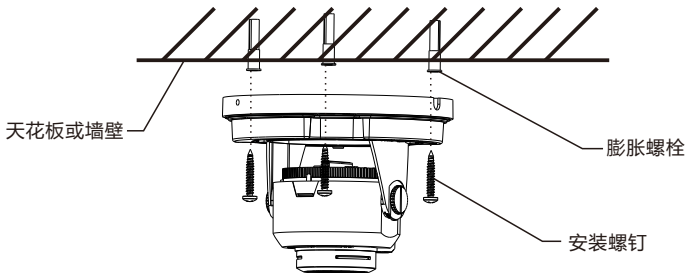

- 6、调整镜头的监控方向。拧松镜头角度调节螺钉，手动旋转球体，镜头能够水平、垂直转动。转动镜头后方的旋转部件，将调节至 $\pm 90^\circ$ 时为走廊模式， $0^\circ$ 时为普通模式。调整时不宜用力过猛，以免损伤部件。调整后，拧紧镜头角度调节螺钉。

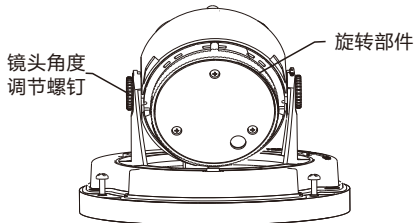
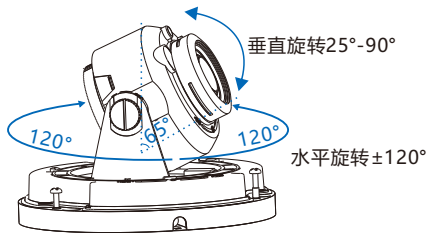

- 7、安装球罩。拿起半球防护外罩，撕下透明罩里面的保护膜，对准半球外罩与底座的螺钉孔位，盖上外罩。然后用螺丝刀将三颗十字盘头防拆螺钉拧紧，将半球防护外罩固定在底座上。最后撕下半球透明罩外面的保护膜。

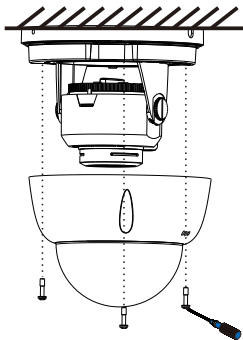

**【说明】**三颗十字盘头防拆螺钉请务必拧紧，使遮光圈紧贴透明罩内壁，否则会产生漏光现象，影响夜间红外灯开启后的效果。

- 8、连接线缆并上电。

## 吊装：

吊装支架和壁装支架不同，但安装方式类似，此处以吊装为例进行说明，壁装时请参考吊装安装步骤说明。

进行吊装或壁装，请确认安装的墙体或天花板厚度和硬度适合固定自攻螺钉，同时其强度也能够承受设备和支架的总重量。

吊装支架尺寸如下图：

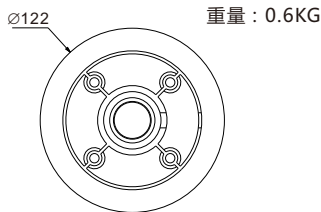
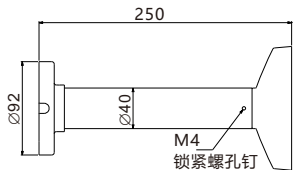

单位：mm

壁装支架尺寸如下图：

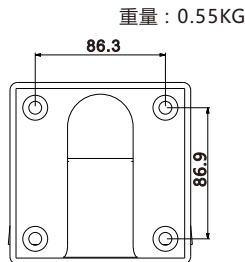
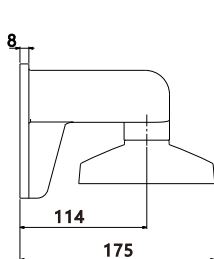
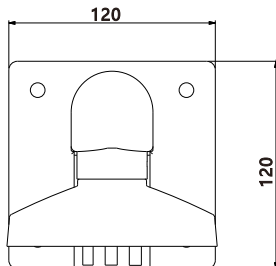

- 1、墙面打孔。根据支架底座孔位，在墙面确认打孔位置并打孔，塞入膨胀螺栓。

如果在安装线缆时采用从安装面顶部出线的方式，还需要在墙面打一个线缆出孔开口。如果采用从侧面出线的方式，需要通过支架底座上的U型线缆通道侧口，将线缆引出。

**【说明】** 打孔选择钻头应与膨胀螺栓外径相配，孔深参考螺栓的长度。

- 2、取下护罩。用螺丝刀拧开半球护罩上的三颗十字盘头防拆螺钉，取下半球护罩。  
护罩取下后放置时不要将透明球面接地，避免刮花。

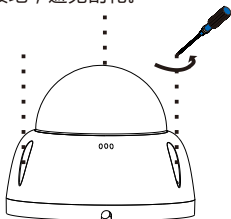

- 3、穿线。采用顶部出线时，将线缆穿过安装面；若采用侧面出线的方式，将线缆穿过支架底座上的U型线缆通道侧口。

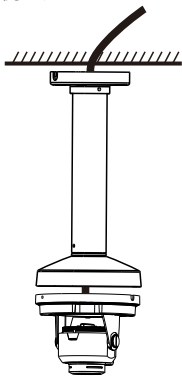

顶部出线

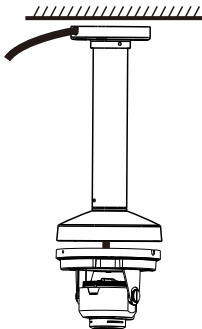

侧面出线

- 4、将设备安装底座上的三个螺钉固定孔对准支架上的三个螺孔，然后将三颗螺钉拧紧，将半球固定在支架上。

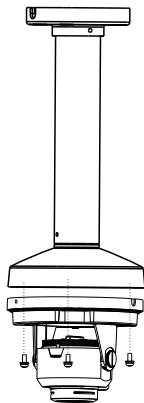

- 5、固定支架。将支架底座上的四个螺钉孔对准安装面上的四个膨胀螺栓孔，将四颗自攻螺钉拧紧到四个塑料膨胀螺栓中，并锁紧，将吊装支架固定在安装面上。

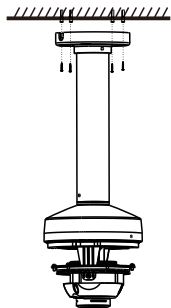

- 6、参考吸顶安装的第6-7步进行镜头方向调节、球罩安装。  
7、连接线缆并上电。

## 五、登录客户端

### 1.最低配置和系统环境

- 处理器：3.3GHz酷睿®i3系列及以上或相同性能的其他处理器
- RAM内存：4GB及以上
- 操作系统：WindowsXP操作系统或更高版本
- 浏览器：推荐使用IE内核浏览器，使用其它内核浏览器会影响客户端部分功能的使用
- DirectX：9.0c

### 2.设备激活

第一次使用时请运行IPCSearch，在IPCSearch中将显示设备的IP地址、网关等信息。若IPC设备所接入的网络有DHCP服务，DHCP服务器将自动给IPC分配IP地址。

- 批量激活：在IPCSearch中选中设备，点击**批量处理**，在弹出的界面中设置admin用户的密码和找回密码时需要用的邮箱，点击**激活**按钮激活设备。设备将自动重启。
- 单个激活：在IPCSearch中选择设备，单击右键，选择**设备激活**。填写用户名、密码、找回密码时需要用到的邮箱。点击**激活**按钮激活设备。设备将自动重启。
- Web客户端激活：也可以通过Web客户端激活。将PC机与设备设为同一网段，登录Web界面。可在界面设置管理员密码和密码恢复邮箱，点击**激活**。

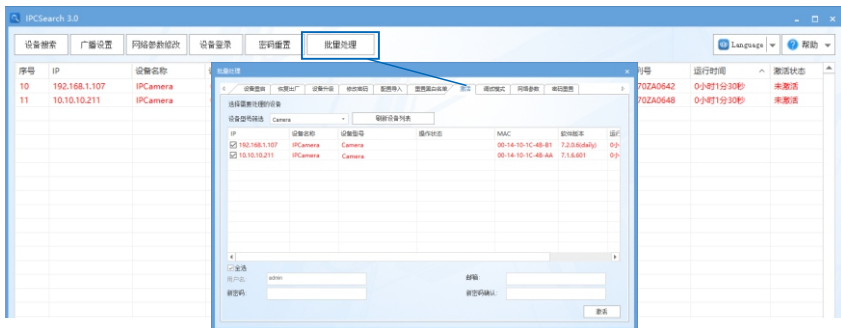

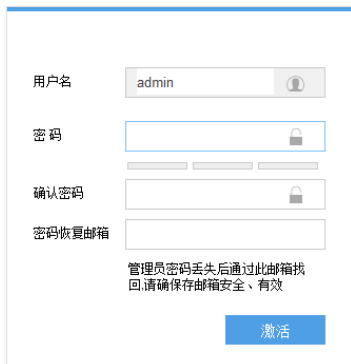

用户名

密码

确认密码

密码恢复邮箱

管理员密码丢失后通过此邮箱找回,请确保邮箱安全、有效

### 3.修改设备IP

点击**修改网络参数**，在弹出的界面中配置网络参数。静态分配IP地址时，请选择自定义地址，填写以太网参数。修改参数配置，需要填写管理员用户用户名（admin）及激活设备时所设置的密码。完成IP配置后，设备将自动重启。

### 4.登录设备

1) 在IPCSearch中双击设备或点击**登录设备**，输入用户名和密码，登录We客户端。



用户名

密码

2) 登录成功后, 下载并安装视频插件 (IE内核浏览器)。

3) 进入客户端后, 直接浏览图像。

**【说明】** 不同型号, 浏览界面略有差异, 请以实际界面为准。更多客户端说明请参考客户端帮助文档。

调整设备方向, 在Web客户端上进行参数调整, 直到浏览画面达到预定要求。

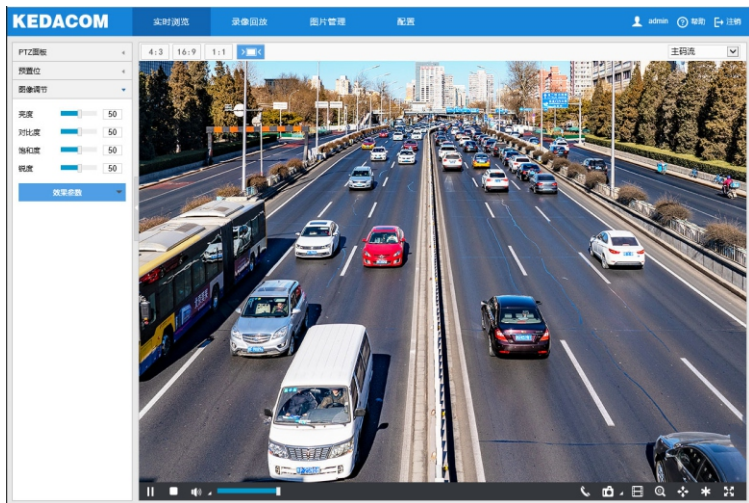



## 附 DC12V线径与传输距离关系表

当线径大小一定, DC 12V电压损耗率低于10%时, 不同传输功率推荐的最大传输距离。(对于DC 12V直流供电设备, 其最大允许电压损耗率为10%。下面表格中所用线缆均为铜线, 铜的电阻率为  $\rho = 0.0175\Omega \cdot \text{mm}^2/\text{m}$ )

距离m 功率W	线径 mm	0.8 ( 20AWG )	1.0(18AWG )	1.25(16AWG)	2.0(12AWG )
	5		38 ( 125 )	61 ( 199 )	96 ( 315 )
10		19 ( 63 )	30 ( 99 )	48 ( 157 )	122 ( 400 )
15		13 ( 42 )	20 ( 66 )	32 ( 105 )	81 ( 267 )
20		10 ( 31 )	15 ( 50 )	24 ( 79 )	61 ( 200 )
25		8 ( 25 )	12 ( 40 )	19 ( 63 )	49 ( 160 )
30		6 ( 21 )	10 ( 33 )	16 ( 52 )	41 ( 133 )
35		5 ( 18 )	9 ( 28 )	14 ( 45 )	35 ( 114 )
40		5 ( 16 )	8 ( 25 )	12 ( 39 )	31 ( 100 )
45		4 ( 14 )	7 ( 22 )	11 ( 35 )	27 ( 89 )
50		4 ( 13 )	6 ( 20 )	10 ( 31 )	24 ( 80 )
55		3 ( 11 )	6 ( 18 )	9 ( 29 )	22 ( 73 )
60		3 ( 10 )	5 ( 17 )	8 ( 26 )	20 ( 67 )
65		注1	5 ( 15 )	7 ( 24 )	19 ( 62 )
70		注1	4 ( 14 )	7 ( 22 )	17 ( 57 )
75		注1	4 ( 13 )	6 ( 21 )	16 ( 53 )
80		注1	4 ( 12 )	6 ( 20 )	15 ( 50 )
85		注1	4 ( 12 )	6 ( 19 )	14 ( 47 )
90		注1	3 ( 11 )	5 ( 17 )	14 ( 44 )
95		注1	3 ( 10 )	5 ( 17 )	13 ( 42 )
100		注1	3 ( 10 )	5 ( 16 )	12 ( 40 )

**【备注】** 1.传输功率超过60W, 需要用1.0 ( 18AWG ) 或以上线径。

2.线径要求适用于单根、实心、圆形的铜线, 多股绞线的电缆AWG 值是由所有线的总横截面积决定。

## 保修说明

本保修卡适用于您购买的本公司系列产品。

1. 免费保修期一年（仅限中国大陆地区，中国大陆以外地区请参考英文说明）。
2. 凡保修期内，由于本产品自身引起的故障，请与公司售后服务部联系。
3. 保修时我们将使用您的保修卡信息，请认真填写。
4. 以下情况，属于有偿保修范围：
  - 人为原因造成的设备故障
  - 因使用环境不符合本产品要求造成的故障
  - 因不可抗力造成的产品损坏
  - 无保修卡
  - 已过免费保修期

## 用户信息

用户名称：

详细地址：

传真：

电话：

邮箱：

邮编：

产品名称：

产品型号：

购买日期：

## I. Preface

Thank you for purchasing our product. If there is any question, please do not hesitate to contact us.

These instructions are intended to ensure that the user can use the product correctly to avoid danger or property loss. Please read this Guide carefully before using the product, and keep it properly for future reference. If the product cannot work normally or is damaged because the user does not follow the safety instructions, we shall not assume any responsibility. Thanks for your cooperation.

## II. Safety Instruction

### 1. Power Supply

- During installing and using the device, please follow local electrical safety regulations strictly.
- Please use power supply in the safe voltage range of our product. Make sure if the power supply is correct before running the device.
- Please install an easy-to-use breaker during installation and wiring in case it is necessary to make an emergency break.
- Please prevent the power cord from being trampled or pressed especially the plug, socket and the connecting part led out from the device.
- Please connect cables of power, alarm, audio and RS-485 with the power off. Hot-line wiring is not allowed.

### 2. Working Environment

- Do not focus the camera lens on strong light such as the sun or incandescent lamp; otherwise the strong light will cause overexposure or light leak (not camera malfunction), which may shorten camera lifetime.
- Please transport, use and store the device within defined humidity and temperature ranges.
- Do not expose it in damp, dusty, extremely hot or cold places or places with intense electromagnetic radiation or with unstable lighting.
- Keep the camera away from water or any liquid to avoid damage to internal components.
- To avoid heat accumulation, please do not block the ventilation around the device.
- While shipping the camera, pack it in the factory packing or use materials with equivalent quality.
- When shipping, storing and installing the device, try to prevent it from damages caused by pressure, violent vibration and soaking.
- This product is not water-proof and cannot be used outdoor alone.

Working Environment	
Voltage	DC12V±10%/POE, Power: 11W max
Temp.	-40°C~70°C
Humidity	10%~95% (non-condensing)
Altitude	-60m~3000m
Pressure	86kPa~106kPa

### **3. Daily Maintenance**

- Do not touch the heat component of the device directly to avoid empyrosis.
- When the lens is contaminated by dust or grease, use cotton cloth or lens clean cloth to wipe it off. When it is hard to clean, dip some lens cleanser and wipe gently and rotate outward from the middle until it is clean. Never apply any organic solvent with ethanol or benzene to clean the lens and housing.
- Do not disassemble or repair the device in any way by yourself. We shall not assume any responsibility for problems caused by unauthorized repair or maintenance.
- If the product does not work properly, please contact your dealer or the nearest service center.

### **4. Special Statement**

- The product appearance is subject to the actual device and picture in this Guide is for reference only..
- Every effort has been made to ensure the accuracy and validity of this Guide. Any update of this Guide caused by version upgrade is subject to change without notice.
- This Guide is made for multiple models but it will not illustrate one by one. Please refer to it according to the actual products you are using.
- This device can be used after being activated through IPCSearch with a valid email address for claiming the password. Please download IPCSearch from our web: <https://www.kedacom.com/softtools/index.jhtml>.
- To ensure the safety of device on internet, it is strongly recommended that you set a strong password which is composed of at least 2 kinds of the following, digits, case-sensitive letters or specific symbols, and whose length ranges from 8 to 16 bits. Please modify the password periodically and once every 3 months is recommended. If the device is used in highly risky environment, suggest modifying the password monthly or weekly. Please keep your user name and password safe.
- Accessing this device to the internet is at user's own risk, including but not limited to the possible network attack, hacker attack, virus infection and etc. This company will not assume any responsibility for problems of product abnormality and information disclosure caused thereof. We shall provide technical support relating to the products in time.
- For the latest documents, please download at our website [www.kedacom.com](http://www.kedacom.com).

### III. Appearance and Interface

#### Dimensions:

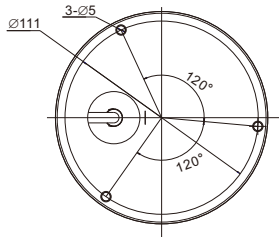
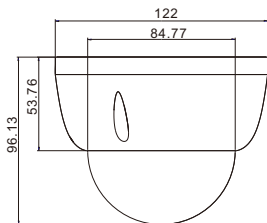

Unit: mm

#### Components:

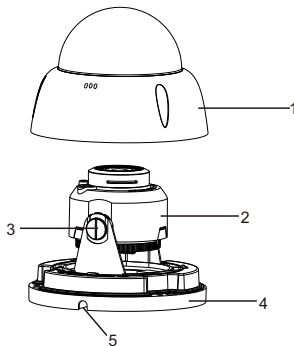

No.	Part Name
1	Semi-dome
2	Movement module
3	Lens-adjusting screw
4	Base
5	Side wiring hole

Buttcock line:

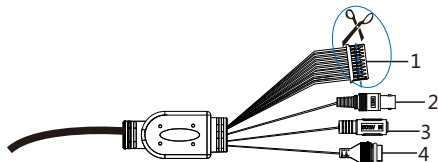

Table 1 Wiring Interface

Interface	Interface Name	Function
1	User cable group	Including alarm in / out, audio in / out, RS-485 serial port and etc.
2	Video output	Local video output composite video signal, BNC port
3	Power supply	Connect to power supply of DC12V
4	Network	Connect to network access devices like a switch

Table 2 Cable Group Interface

Interface	No.	Color	Name	Function
Cable Group	1	Yellow	RS-485-A	RS-485 serial port, to control external devices such as third-party device
	2	Green	RS-485-B	
	3	Pink	AUDIO IN-1	Audio input port, for inputting audio signal or intercommunication
	4	White	AUDIO IN-2	
	5	B / W	AUDIO OUT	Audio output port, for outputting audio signal
	6	Light Green	AUDIO GND	Audio grounding
	7	Gray	ALARM IN	Alarm input port, for inputting alarm signal
	8	Red	ALARM IN GND	Alarm input grounding
	9	Blue	ALARM OUT-1-A	Alarm output port, for outputting alarm signal
	10	Purple	ALARM OUT-1-B	

## IV. Installation

The camera supports ceiling mount, wall mount, pendent mount and wall bracket mount. As pendent mount and wall bracket mount need brackets but the device itself does not contain brackets.

Camera weight: 0.6kg (net)

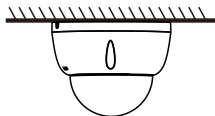

Ceiling mount

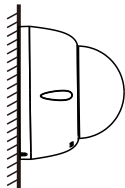

Wall mount

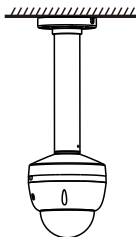

Pendent mount

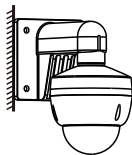

Wall bracket mount

When installing the device outdoor, a waterproof joint box is necessary to get good waterproofness. The waterproof joint box is optional.

The waterproof joint box and its installation sketch are shown below. Please refer to the Quick Start Guide of the waterproof joint box for detailed installation.

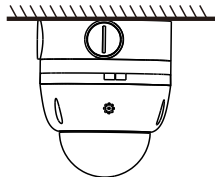
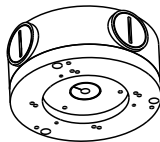
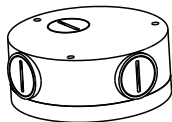

### Ceiling Mount:

The installation steps of ceiling mount and wall mount are the same. This part will take ceiling mount as an example to introduce the installation steps. During the installation, please keep the transparent dome clean both inside and outside.

You can perform ceiling or wall mount when the wall or ceiling are thick and solid enough for fixing self-tapping screws and meanwhile strong enough for bearing the device.

1. Take down the dome housing. Use a screw driver to screw off the 3 cross recessed pan tamper screws and take down the dome housing.

**Note:**

- Do not put the transparent dome housing on the ground when taking it down to avoid scratching.
- Prevent scratching the dome housing during operation; otherwise the image quality will be affected.
- Do not peel off the protective film inside and outside the dome housing until finishing installation.

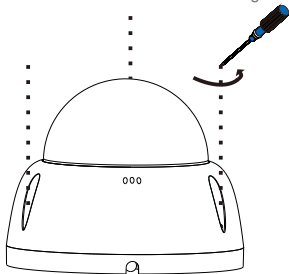

2. Install TF card (optional). Insert a TF card into the slot as shown in the following picture. The max supported memory of TF card is 256G. After insertion, hot-swapping the TF card is not recommended.

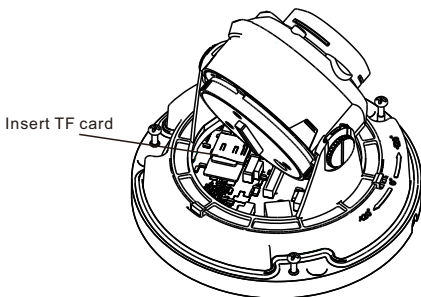

3. Paste the installation sticker. Pick out the installation sticker from the attachment and stick it to the ceiling or wall according to the surveillance area. Size of the sticker is shown in the following picture.



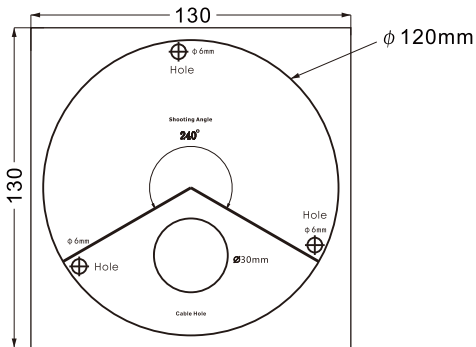

4. Drill holes. Drill 3 basic holes with plastic expansion screw bolts at the 3 "cross" hole marks on the sticker and insert the 3 expansion screw bolts thoroughly into the holes.

**[Note]** If routing the cables from the top of the mounting surface, a cable outlet hole is also needed at the part of "Cable Hole" on the sticker. If routing the cables from the profile side of the device, lead the cables out through the U-shaped groove at the side of the dome base.

5. Fix the device base onto the wall. Adjust the base of the device, route the cables through the cable hole, align the 3 screw holes on the device base to the 3 plastic expansion screw bolts on the mounting surface, tighten the 3 tapping screws into the expansion screw bolts and fix the dome camera onto the surface.

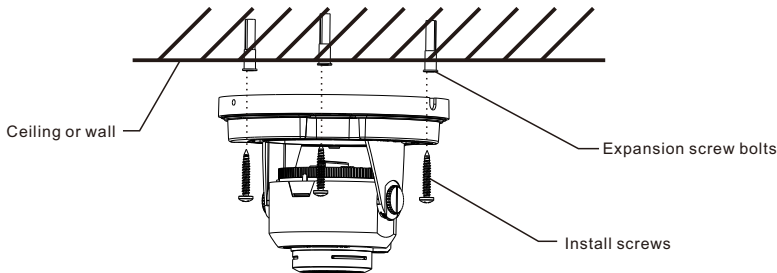

6. Adjust lens surveillance direction. Loosen the lens angle-adjusting screw, rotate the dome manually and the lens will rotate in pan and tilt directions. Rotate the rotating part at the back of the lens. When the lens rotates till  $\pm 90^\circ$ , set the mode as corridor mode while  $0^\circ$  as common mode. It's inadvisable to rotate too hard during adjustment to avoid damage to the parts. After finishing adjustment, tighten the lens angle-adjusting screw.

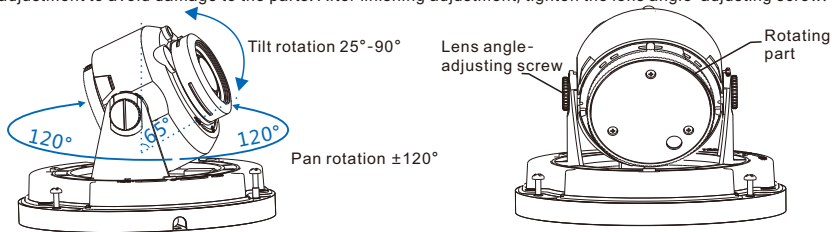

7. Install dome housing. Pick up the dome housing, peel off the protective film inside the transparent dome, align the screw holes on the dome housing to that on the base and cover the housing. Tighten the 3 cross recessed pan tamper screws with a screw driver and fix the dome housing onto the base. Finally, peel off the protective film outside the transparent dome housing.

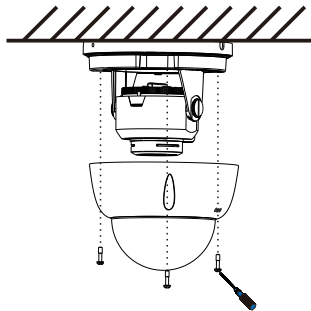

**[Note]** Please tighten the three cross recessed pan tamper screws so that the darkening ring will cling to the inner surface of the dome housing; otherwise, it may cause light leakage and will affect image quality at night when the IR lights are on.

8. Connect cables and power on the device.

### Pendent Mount:

Though the pendent bracket is different with the wall bracket, their installation method is quite similar. Now take the pendent bracket as an example to illustrate the installation steps, which is also a reference for wall bracket mount.

When choosing pendent or wall bracket mount, please make sure that the mounting wall or ceiling is thick and solid enough for fixing tapping screws and meanwhile strong enough for bearing the total weight of the device and the bracket.

Size of the pendent bracket is shown below:

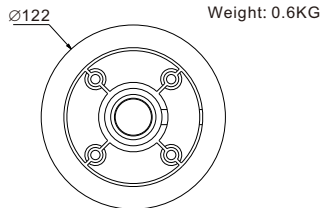
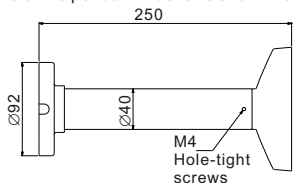

Unit: mm

Size of the wall bracket is shown below:

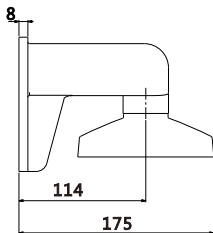
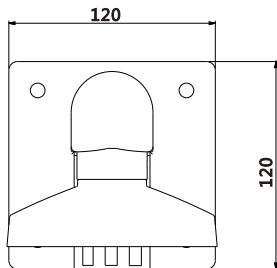

Weight: 0.55KG

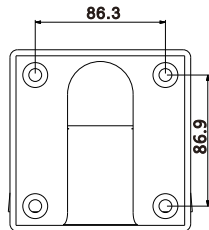

1. Drill holes. Determine the hole positions on the wall according to the holes on the base of the bracket, drill holes on the wall and insert expansion screw bolts.

If routing the cables from the top of the mounting surface, a cable outlet hole is also needed on the wall. If routing the cables from the profile side of the device, lead the cables out through the U-shaped groove at the base of the bracket.

[Note] The outer diameter of the drill should match with that of the expansion screw bolt and the hole deepness match the screw bolt length.

2. Take down the dome housing. Use a screw driver to screw off the 3 cross recessed pan tamber screws and take down the dome housing.  
Do not put the transparent dome housing on the ground when taking it down to avoid scratching.

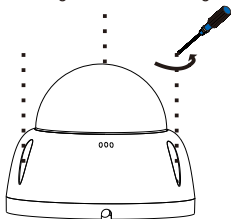

3. Route cables. If routing the cables from the top, lead the cables through the mounting surface. If routing the cables from the profile side of the device, lead the cables out through the U-shaped groove at the base of the bracket.

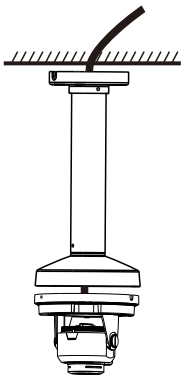

Top wiring

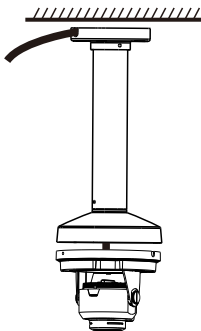

Side wiring

4. Align the 3 screw holes on the device base to the 3 screw holes on the bracket, tighten the 3 screws and fix the dome camera onto the bracket.

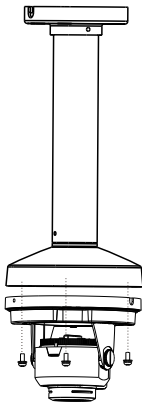

5. Fix bracket. Align the 4 screw holes on the bracket base to the 4 expansion screw bolts on the mounting surface, tighten the 4 tapping screws into the expansion screw bolts and fix the pendent bracket onto the mounting surface.

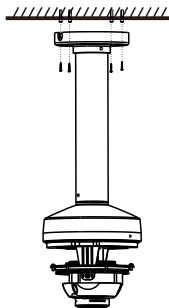

6. Refer to Step 6 -7 of Ceiling Mount for lens direction adjustment and dome housing installation.  
7. Connect cables and power on the device.

## V. Login to Client

### 1. Minimum configurations and system requirements:

- Processor: 3.3 GHz CORE®i3 series or other equivalent processors
- RAM Memory: 4GB or above
- Operating System: Windows XP or newer version
- Browser: suggest using IE Kernal browser, other Kernal browsers may affect some functions of the client
- DirectX : 9.0c

### 2. Device Activation

When using the device for the first time, run IPCSearch: it will search devices in LAN automatically and display the list of device IP address, gateway and etc. If the network provides DHCP service, DHCP server will assign IP for the camera automatically.

- Batch: Select the device and click "**Batch processing**". In the popup interface, set admin user's password and the email address to find back the password. Click "**Activate**" and it will reboot automatically.
- Individual: Select the device from IPCSearch and right click to select "**Active**". Fill admin user name and password and the e-mail address to find back the password. Click "**Activate**" and it will reboot automatically.
- Web client: the device can also be activated through the web client. Set PC and the device in the same network segment and login to the web. User can set admin password and password reset email on the interface and click "**Activate**".

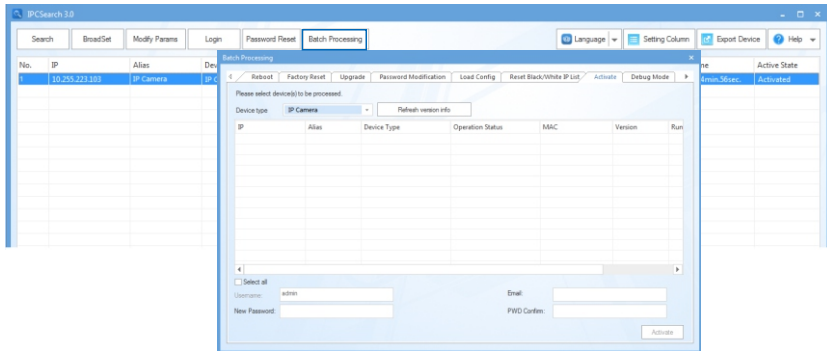

---

User Name  

Password  

Confirm Password  

Claim Email

When admin's password gets lost, find it back through this email. Make sure this email address is safe and valid.

### 3. Modify device IP address

Click "**Modify Params**" and set the network parameters. When configuring a static IP for the camera, please check "Custom device address (Close DHCP)" and fill the Ethernet parameter. During the modification, the user name (admin) and the password set before activation should be entered. After configuration, the camera will reboot automatically.

### 4. Login to the device

1) Double click the device in IPCSearch or click "Login". Enter user name and password to login the web client.

---

User Name  

Password  

2) After login, download and install the plug-in (IE Kernal browser).

3) Re-login to the web client and view live video directly.

[Note]: Interface of different models may differ. Please subject it to the actual product. Please refer to the Help file for detailed explanation.

Adjust camera direction, configure camera parameters in web client until the live view meets requirement.





## Appendix: DC12V Wire Diameter VS. Transmission Distance

The recommended max transmission distance when the wire diameter is certain and the DC12V voltage loss rate is less than 10% (For DC12V powered devices, the maximum allowed voltage loss rate is 10%. All the wires in the following table are cooper wires, whose electrical resistivity is  $\rho = 0.0175\Omega \cdot \text{mm}^2/\text{m}$ )

Distance (m) Power (W)	Diameter (mm)	0.8 ( 20AWG )	1.0(18AWG )	1.25(16AWG)	2.0(12AWG )
	5		38 ( 125 )	61 ( 199 )	96 ( 315 )
10		19 ( 63 )	30 ( 99 )	48 ( 157 )	122 ( 400 )
15		13 ( 42 )	20 ( 66 )	32 ( 105 )	81 ( 267 )
20		10 ( 31 )	15 ( 50 )	24 ( 79 )	61 ( 200 )
25		8 ( 25 )	12 ( 40 )	19 ( 63 )	49 ( 160 )
30		6 ( 21 )	10 ( 33 )	16 ( 52 )	41 ( 133 )
35		5 ( 18 )	9 ( 28 )	14 ( 45 )	35 ( 114 )
40		5 ( 16 )	8 ( 25 )	12 ( 39 )	31 ( 100 )
45		4 ( 14 )	7 ( 22 )	11 ( 35 )	27 ( 89 )
50		4 ( 13 )	6 ( 20 )	10 ( 31 )	24 ( 80 )
55		3 ( 11 )	6 ( 18 )	9 ( 29 )	22 ( 73 )
60		3 ( 10 )	5 ( 17 )	8 ( 26 )	20 ( 67 )
65		Note 1	5 ( 15 )	7 ( 24 )	19 ( 62 )
70		Note 1	4 ( 14 )	7 ( 22 )	17 ( 57 )
75		Note 1	4 ( 13 )	6 ( 21 )	16 ( 53 )
80		Note 1	4 ( 12 )	6 ( 20 )	15 ( 50 )
85		Note 1	4 ( 12 )	6 ( 19 )	14 ( 47 )
90		Note 1	3 ( 11 )	5 ( 17 )	14 ( 44 )
95		Note 1	3 ( 10 )	5 ( 17 )	13 ( 42 )
100		Note 1	3 ( 10 )	5 ( 16 )	12 ( 40 )

### [Note]:

1. When the transmission power is over 60W, you must use wires with diameter of 1.0 (18AWG) or above;
2. The requirements of diameter apply to single, solid and round cooper wire. The AWG value of multi-stranded wires is dependent on the total CSA (Cross Sectional Area) of all wires.

## **Kedacom Two (2) Year Limited Hardware Warranty**

### **WHAT IS COVERED BY THIS WARRANTY?**

Kedacom warrants the Kedacom-branded hardware product and accessories contained in the original packaging (hereinafter referred to as "Kedacom Product") against defects in materials and workmanship when used normally in accordance with Kedacom's published guidelines for a period of TWO (2) YEARS from the date of original retail purchase in areas other than mainland China by the end-user purchaser (hereinafter referred to as "Warranty Period"). For the Kedacom Product purchased in mainland China, see the simplified Chinese version of this warranty for details. Kedacom's published guidelines include but are not limited to information contained in technical specifications, user guides, and service communications. The preceding applies unless otherwise agreed in the contract.

### **WHAT IS NOT COVERED BY THIS WARRANTY?**

This warranty does not apply to any non-Kedacom branded hardware products or any software, even if packaged or sold with Kedacom hardware. Manufacturers, suppliers, or publishers, other than Kedacom, may provide their own warranties to you but Kedacom, in so far as permitted by law, provides their products "AS IS". Software distributed by Kedacom with or without the Kedacom brand (including, but not limited to system software) is not covered by this warranty. Please refer to the licensing agreement accompanying the software for details of your rights with respect to its use. Kedacom does not warrant that the operation of the Kedacom Product will be uninterrupted or error-free. Kedacom is not responsible for damage arising from failures to follow instructions relating to the Kedacom Product's use.

This warranty does not apply: (a) to consumable parts, such as batteries, unless failure has occurred due to a defect in materials or workmanship; (b) to cosmetic damage, including but not limited to scratches, dents, and broken plastic on ports; (c) to damage caused by use with another product; (d) to damage caused by acts outside the control of Kedacom, including without limitation acts of God, accidents, abuse, misuse, fire, storms, earthquakes, flood, or other external cause; (e) to damage caused by exposure of the product to heat, bright light, sun, liquids, sand, or other contaminants; (f) to damage caused by operating the Kedacom Product outside Kedacom's published guidelines; (g) to damage caused by service (including upgrades and expansions) performed by anyone other than a representative of Kedacom, Kedacom employee, or authorized Kedacom agent; (h) to an Kedacom Product that has been modified to alter functionality or capability without the written permission of Kedacom; (i) to defects caused by normal wear and tear or otherwise due to the normal aging of the Kedacom Product, or (j) if any serial number has been removed or defaced from the Kedacom Product.

### **YOUR RESPONSIBILITIES**

If your Kedacom product is capable of storing data and other information, you should make periodic backup copies of the information contained on the storage media to protect the contents and as a precaution against possible operational failures.

Before receiving warranty service, Kedacom or its authorized agents may require that you furnish proof of purchase details, respond to questions designed to assist with diagnosing potential issues, and follow Kedacom's procedures for obtaining warranty service. Before submitting your Kedacom Product for warranty service, you should maintain a separate backup copy of the contents of its storage media, remove all personal information that you want to protect, and disable all security passwords.

During warranty service, it is possible that the contents of the Kedacom product's storage media will be lost, replaced or reformatted. In such an event, Kedacom and its authorized agents are not responsible for any loss of data or other information contained on the storage media or any other part of the Kedacom product serviced.

Following warranty service, your Kedacom Product or a replacement product will be returned to you as your Kedacom Product was configured when originally purchased, subject to applicable updates. You will be responsible for reinstalling all other data and information. Recovery and reinstallation of other data and information are not covered under this warranty.

### **WHAT WILL KEDACOM DO IF THE WARRANTY IS BREACHED?**

If during the Warranty Period, you submit a valid claim to Kedacom or an authorized Kedacom agent, Kedacom will, at its option, (i) repair the Kedacom Product using new or previously used parts that are equivalent to new in performance and reliability, or (ii) exchange the Kedacom Product for a refund of your purchase price.

A Kedacom replacement part or product, including a user-installable Kedacom part that has been installed in accordance with instructions provided by Kedacom, assumes the remaining warranty of the Kedacom Product or ninety (90) days from the date of replacement or repair, whichever provides longer coverage for you. When a product or part is replaced or a refund provided, any replacement item becomes your property and the replaced or refunded item becomes Kedacom's property.

Kedacom reserves the right to refund the purchase price as its exclusive warranty remedy.

### **HOW TO OBTAIN WARRANTY SERVICE?**

To seek warranty service, please contact a local authorized Kedacom agent. When contacting the agent via telephone, other charges may apply depending on your location.

### **User Information**

Complete the form below and keep for ready reference.

User Name:	
Address:	Postal Code:
Tel:	Mobile:
Fax:	E-Mail:
Product Name:	Product Model:
Date of Purchase:	

客户咨询热线：400-828-2866

**KEDACOM**

苏州科达科技股份有限公司

Suzhou Keda Technology Co.,Ltd.

中国: 江苏省苏州市高新区金山路131号(215011)

Tel: +86-512-6841 8188 Fax: +86-512-68412699

Suzhou Keda Technology Co.,Ltd.

Singapore: 627A Aljunied Road, #09-07, BizTech Centre, Singapore 389842

Tel: +65-6842-5700 Fax: +65-6842-5900

05.03.800491 (V1.2) 20200518